



PowerX International, LLC
21860 Watertown Road
Waukesha, WI 53186
Ph: (414) 988-6202

Model: C55-X

SINGLE ACTING SPRING RETURN CYLINDER

PART LIST

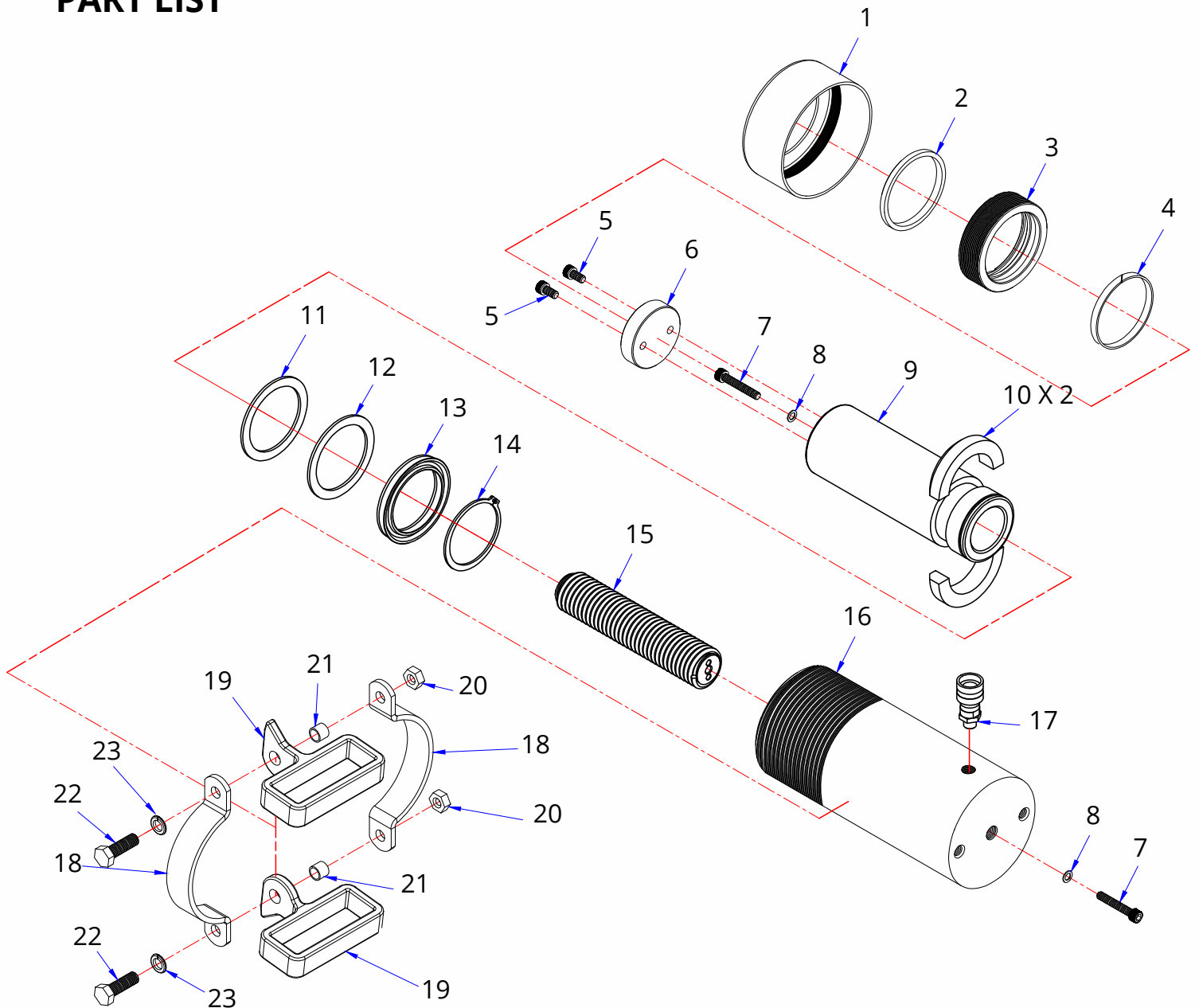



PowerX International, LLC
21860 Watertown Road
Waukesha, WI 53186
Ph: (414) 988-6202

Repair Parts List				
Item	Description	Qty.	Part Number	
			C55-4	C55-6
1	Rubber Protective Cover	1	PSV-C124	PSV-C124
2	Wiper *	1	PSV-C125	PSV-C125
3	Stop Ring	1	PSV-C126	PSV-C126
4	Place Holder	1	PSV-C127	PSV-C127
5	Saddle Screw	2	PSV-C128	PSV-C128
6	Saddle	1	PSV-C129	PSV-C129
7	Screw	2	PSV-C130	PSV-C130
8	Copper Washer *	2	PSV-C131	PSV-C131
9	Piston Rod	1	PSV-C132	PSV-C146
10	2-Piece Rod Bearing	1	PSV-C133	PSV-C133
11	Piston Washer *	1	PSV-C134	PSV-C134
12	Back-Up Ring *	1	PSV-C135	PSV-C135
13	U-Cup *	1	PSV-C136	PSV-C136
14	Retaining Ring	1	PSV-C137	PSV-C137
15	Retracting Spring	1	PSV-C138	PSV-C147
16	Cylinder Body	1	PSV-C139	PSV-C148
17	Coupler	1	PSV-C015	PSV-C015
18	Bracket	2	PSV-C140	PSV-C140
19	Handle	2	PSV-C141	PSV-C141
20	Nut	2	PSV-C142	PSV-C142
21	Spacer	2	PSV-C143	PSV-C143
22	Screw	2	PSV-C144	PSV-C144
23	Lock Washer	2	PSV-C145	PSV-C145

* Denotes items included in the PXRPK-C55 repair kit